

Suzuki Samurai 1 Inch and 2 Inch Body Lift Kit (SKU# SSP-BL)

Installation Instructions

Background: These instructions are designed for installing the 2" body lift. Our approach is to raise the entire body and install all the spacers at once. These instructions can also be used successfully when installing the 1" body lift. However, when installing a 1" body lift, some have found it easier to install the spacers, one side at a time. This could be a better approach especially if you do not have a twin post lift.



We recommend reading these instructions completely through, before beginning the job. This will insure a greater margin of success and make the job a more pleasurable experience.

CAUTION: Safety glasses should be worn at all times when working with vehicles and related tools and equipment.



FOR ADDITIONAL COPIES OF THESE AND OTHER INSTRUCTIONS GO TO:
www.lowrangeoffroad.com and click on the "INSTRUCTIONS" tab.

Suggested Tools:

- Standard Screwdriver
- Phillips Screwdriver
- Channel-Lock Pliers
- Sockets: 10, 12, 14, 17, 19 mm
- Combination Wrench: 12 mm
- Twin Post Lift
- Under Hoist Jack Stand
- Floor Jack and (4) Safety Stands
- Pry Bar
- Wheel Chocks
- Permanent Marker

BODY HARDWARE IDENTIFICATION

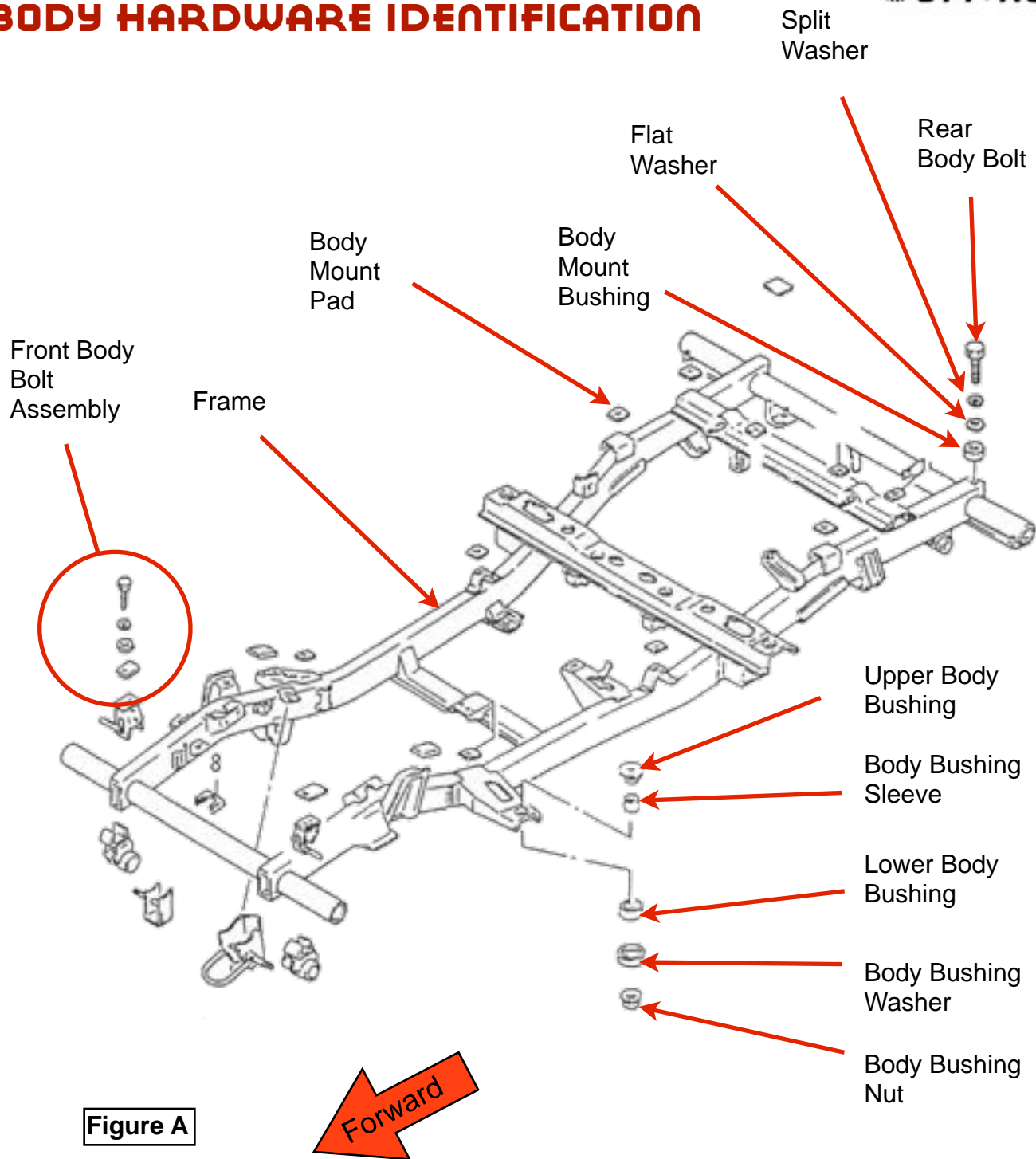

BODY SPACER LOCATIONS & SIZING

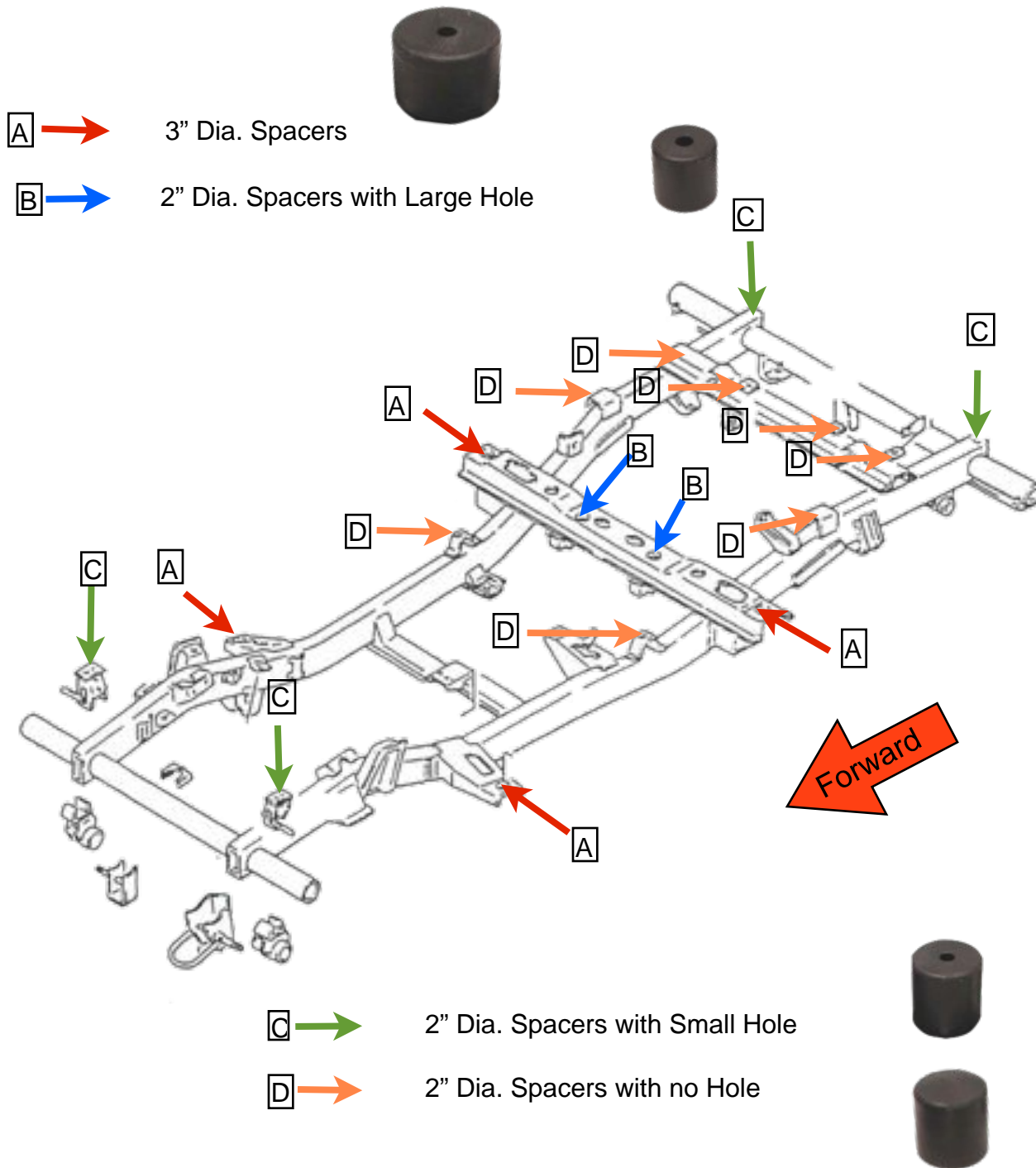

Figure B

BODY LIFT KIT COMPONENT PLACEMENT

"A" BODY MOUNT ASSEMBLY

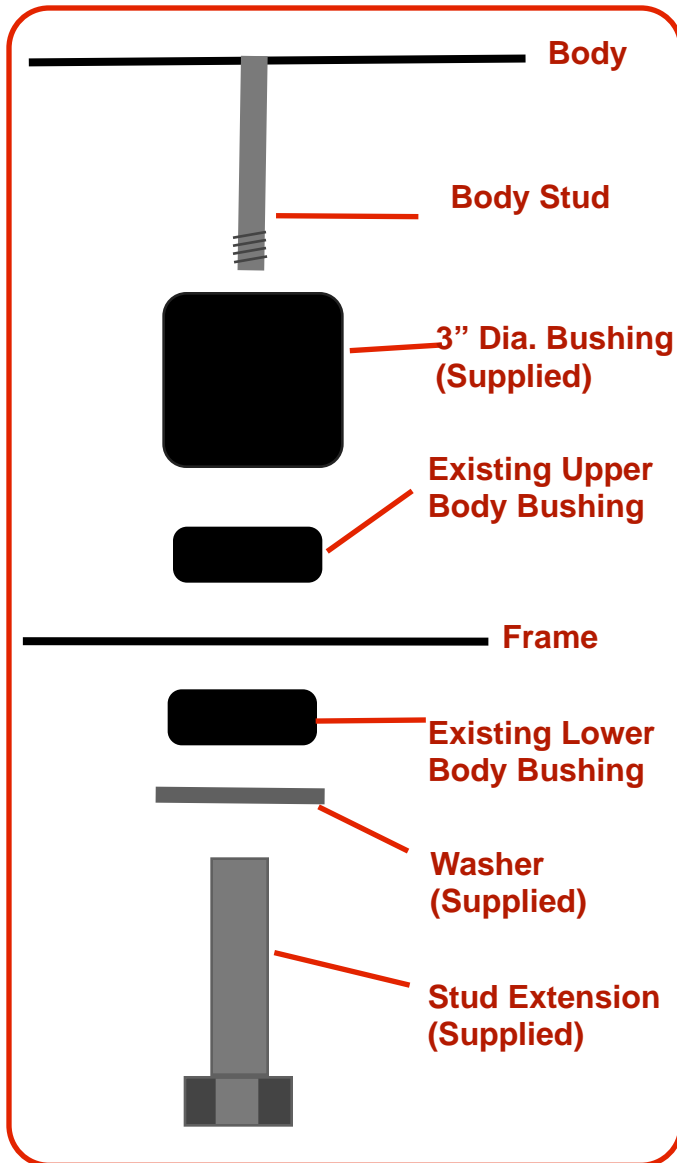

Figure C

"B" BODY MOUNT ASSEMBLY

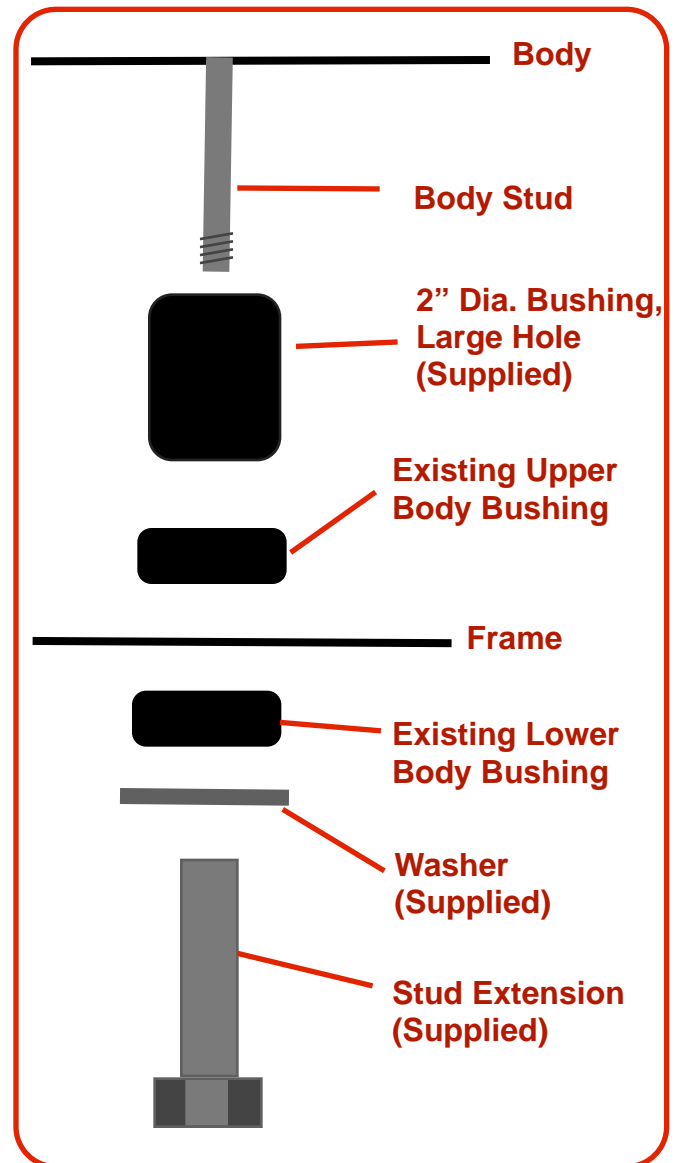

Figure D



"C" BODY MOUNT ASSEMBLY

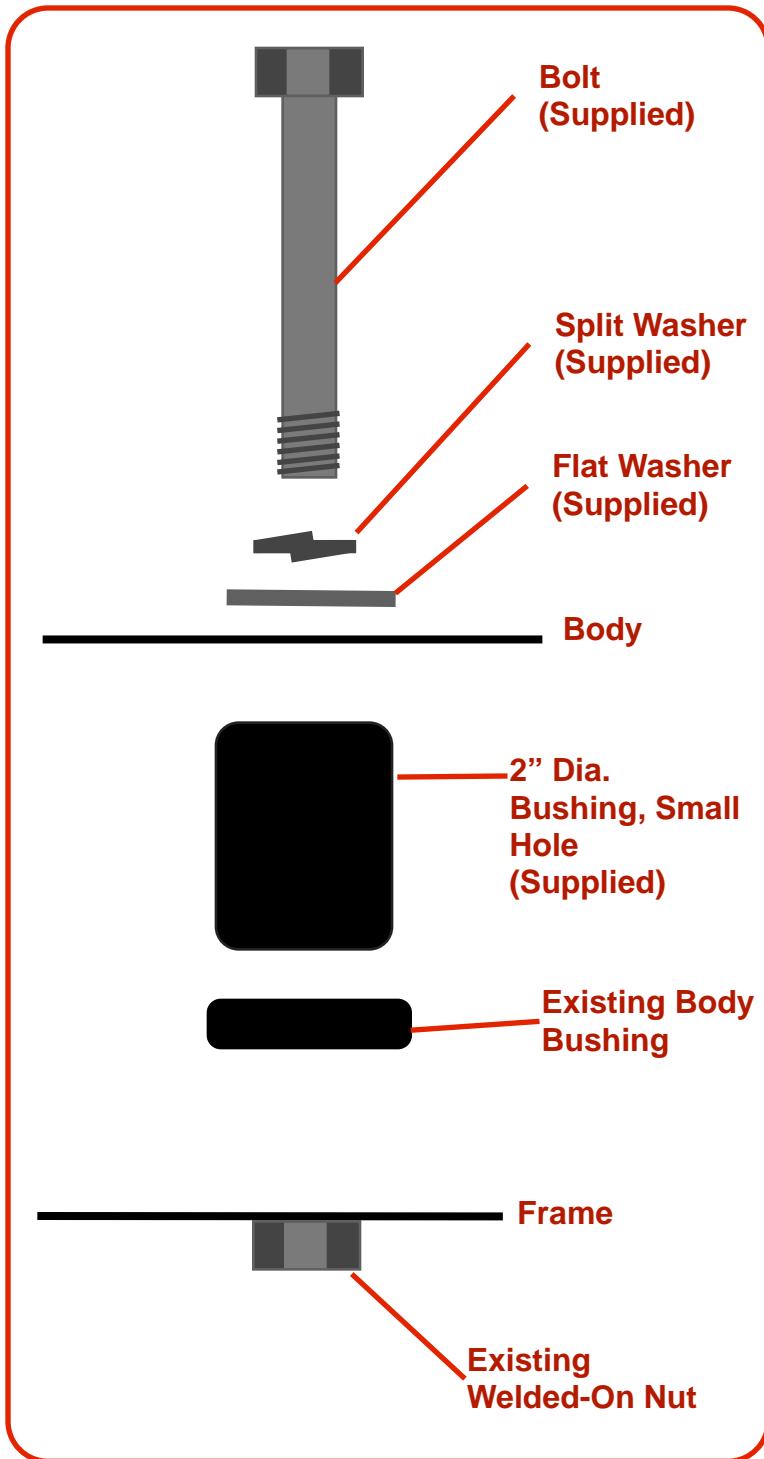

Figure E

"D" BODY MOUNT ASSEMBLY

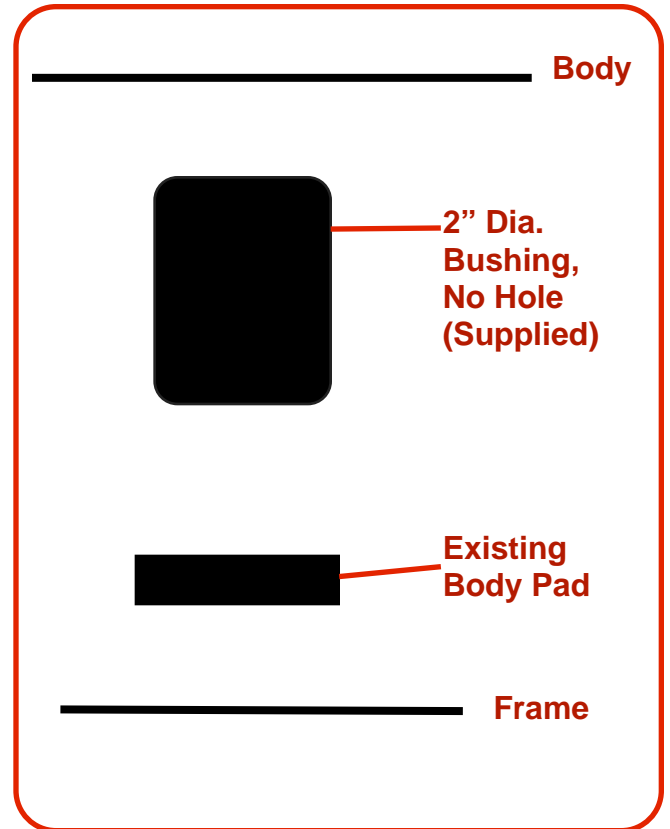

Figure F

Preparing the Vehicle



Lifting Option 1

The preferred method of lifting and supporting the vehicle is the twin post, frame contact, lift. If this is the method you plan to use, position the vehicle as you normally would, however do not lift it at the point of the installation.

Lifting Option 2

If you plan to use another method of lifting and supporting the vehicle, such as a floor jack and safety stands, position the vehicle on a level floor in a clear work area.

A NOTE ABOUT BUMPERS

Rear Bumper: If the Original bumper is still in place, it will need to be removed in order to raise the body. If you chose to reuse the original rear bumper, custom brackets will need to be made. Custom brackets are not supplied in this kit.

If the original front bumper is still being used, it too will need to be removed.

Here again, if you chose to reuse the original front bumper, new mounting brackets will need to be made.

We recommend you consider installing a custom bumper in both front and rear.

Click [HERE](#) to see what bumpers are available through **LOW RANGE OFF-ROAD**.



Step 1

Disconnect the negative battery terminal. This is done to reduce the risk of cable damage and electrical short circuiting resulting electrical fires and component damage.

PREPARING THE FRONT



Removing the Grill

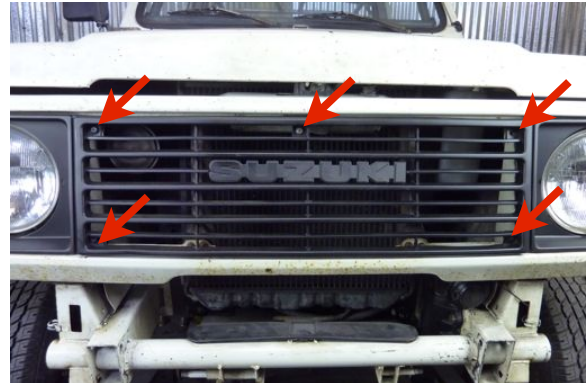

Step 2

Remove the (5) screws securing the grill using a phillips screwdriver.

Tech Tip 2

This picture shows the location of the 5 screws.



Step 3

Remove the driver side of the grill by pulling forward on the grill with your right hand as shown. This will disengage the (2) pins that hold the grill to the fender.



Step 4

Remove the passenger side of the grill by shifting the grill to your right as shown.

Note: Be gentle. The grill pins are easily broken.



Disconnecting the Front Body Mounts



Step 5

Remove the passenger side front body mount bolt, split washer and flat washer using a 14 mm socket.



Step 6

Repeat the previous step on the driver side body bolt.

Disconnecting the Brake Line Bracket



Step 7

Disconnect the brake line bracket by removing these two bolts using a 10 mm socket.

Note: These bolts are located on the passenger side wheel well.



Tech Tip 7

This illustration shows the brake line bracket that is being disconnected in the previous step.



Disconnecting the Heater Components

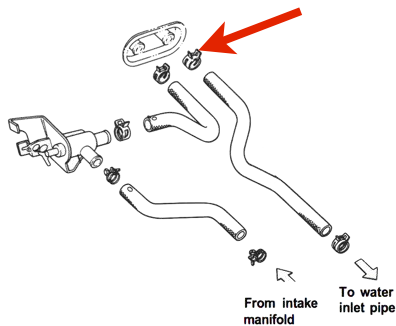

Optional Step

It may be necessary to loosen the heater hose clamp and slide the hose 1/2 way off the heater core pipe. This is done to create sufficient slack when the body is raised during this installation. However, you could wait until you are actually lifting the body to see if this is necessary. It is best not to remove the hose. Coolant will be lost and refilling the system can be time consuming. Additionally, we recommend you use extreme caution when loosening this hose. The heater core to which the hose is connected is very fragile. Use caution if you need to loosen or disconnect this hose so as not to damage the heater core.

Caution: Never remove or loosen heater hoses when the engine is hot. Serious injury could result. Always let the engine cool before working with heater hose and related components.



Step 8

Mark the heat control cable so it can be positioned back in its original position.



Step 9

Unhook the temperature control cable bracket and disconnect the outer cable.



Step 10

Disconnect the heat temperature control inner cable.





Step 11

Disconnect the temperature control valve bracket from the fire wall by removing the (2) phillips screws.



Step 12

Simply let the temperature control valve and cable hang.

Disconnecting Other Under-hood Components



Step 13

Disconnect the distributor primary wire connector located behind the distributor.



Step 14

Disconnect the vacuum tube shown here.





Step 15

Remove the air intake housing nut using a 10 mm socket. Set the air intake housing aside but leave the housing connected to the intake duct.

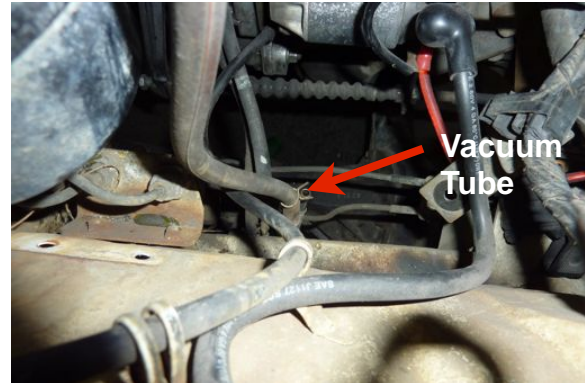

Step 16

Disconnect the evaporative canister vacuum tube.

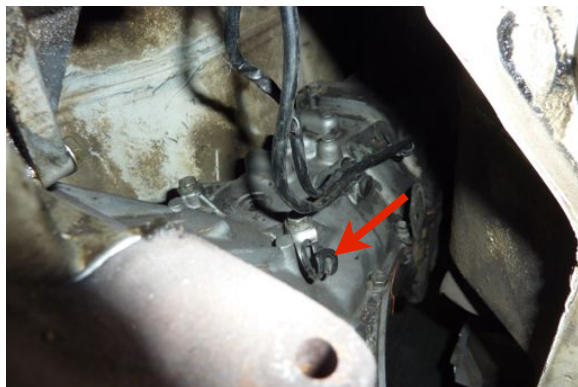

Step 17

Release the (2) transmission wires from the restraint.



Step 18

Release the oil sending unit wire from the restraint.

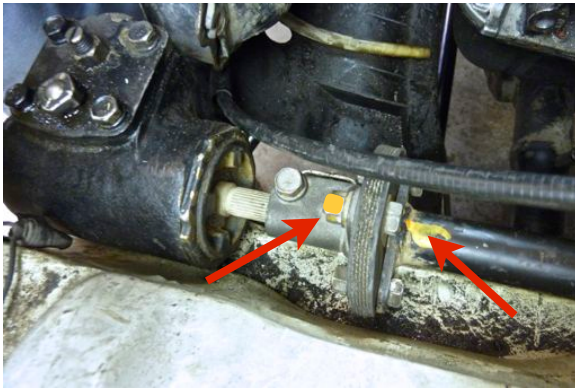

Step 19

Mark the steering shaft and rag joint nut as shown so these parts can be restored to their original orientation when reassembled.



Step 20

Disconnect the steering shaft from the rag joint by removing the (2) bolts using a 12 mm socket and 12 mm box end wrench.

PREPARING THE REAR

Disconnecting Fuel Tank Components



Step 21

Remove the (3) upper fill hose cover screws using a phillips screwdriver.



Step 22

Remove the upper fill hose cover and set it aside.



Step 23

Disconnect the vapor liquid separator by removing (1) screw using a phillips screwdriver. Simply leave the hoses connected and lay the separator aside.



Step 24

Loosen the larger hose clamp using a standard screwdriver, and slide the clamp down on the hose.



Step 25

Loosen the vent tube hose clamp using channel lock pliers and slide it down the hose.



Step 26

Loosen both hoses using channel lock pliers. Be careful not to damage the hoses.



Step 27

Push the smaller hose down about 1 inch. This creates slack in the hose decreasing the risk of damage when the body is raised up.



Step 28

While twisting the larger hose back and forth, push it downward about 1 1/2" off of the filler neck.

Note: Do not disconnect the hose completely.

PREPARING THE INTERIOR

Adjusting Shifter Boots



Step 29

Slide the transfer case shifter boot up the shift lever about one inch.



Step 30

Repeat the previous step on the transmissions shifter boot.



Disconnecting the Rear Body Mounts



Step 31

Remove the driver side rear body bolt, flat washer and bushing, using a 14 mm socket

Note: This bolt, flat washer and bushing will not be reused with this installation and could be discarded.

Step 32

Repeat previous step on the passenger side body bolt



DISCONNECTING THE UNDER SIDE



Step 33

Position the lift arms under the frame according to the illustrations below and raise the vehicle up to a comfortable working height. If you do not have a lift these next few steps could be done with the vehicle on the floor.

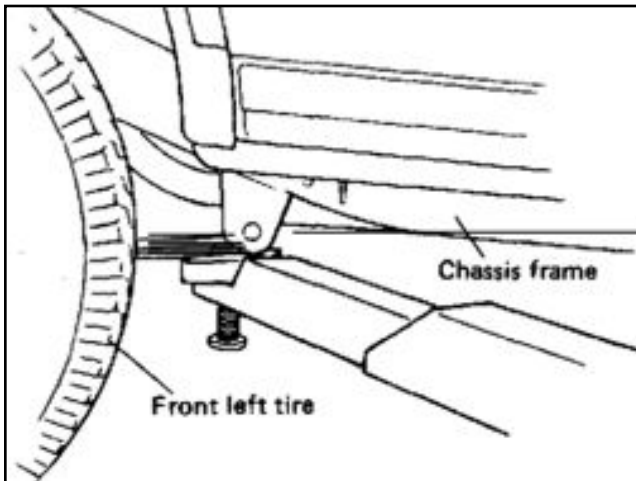

Front Positioning

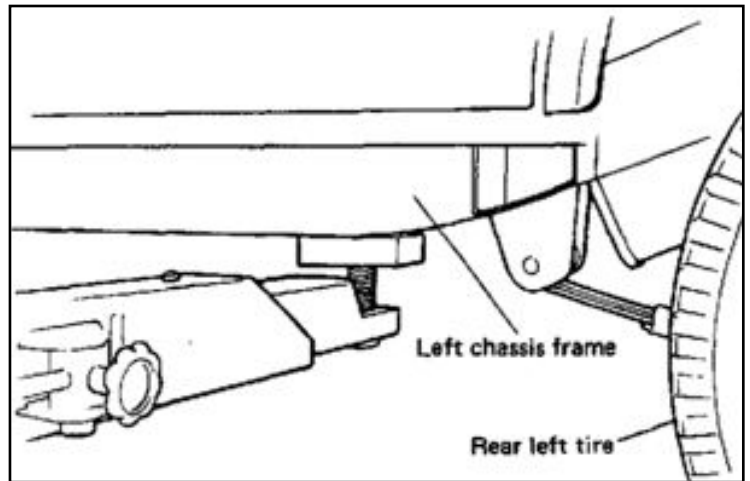

Rear Positioning



Step 34

Remove the lower fuel hose cover by removing the (3) bolts using a 10 mm socket.

Note: This cover is located behind the passenger side rear wheel.



Step 35

Disconnect the park brake cable bracket from the rear axle assembly using a 10 mm socket.





Tech Tip 35

Six of the body mounts look similar to this one. This body mount is located on the passenger side Just behind the front wheel.



Step 36

Loosen the nut using a 14 mm socket.

Note: This nut is treaded onto a stud so there is no need to hold the top end with any tool.

Note: It would be helpful to spray the stud with a good quality penetrating oil before removing it.



Step 37

Remove the nut.



Step 38

Remove the washer. It can be discarded. It will not be needed for this installation.

Note: If the bushing will come off, go ahead and remove it as well. If not, leave it in place until later. If you remove the bushing, keep it safe. You will need it later.



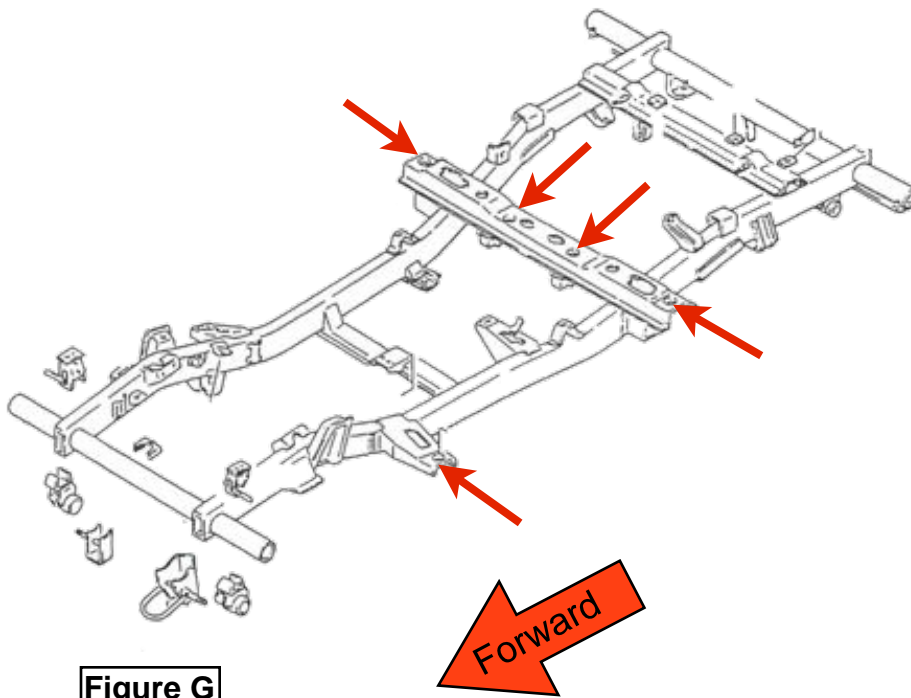

Figure G

Step 39

Repeat **Steps 36 through 38** at the other 5 locations indicated by the arrows.



Step 40

If raised, lower the vehicle back to the ground.

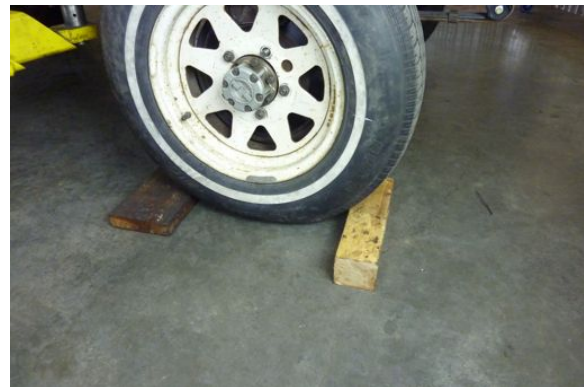

Step 41

Place blocks ahead of and to the rear of one of the tires to keep the vehicle from rolling.





Step 42

Position the lift pads under the pinch weld portion of the body and lift the body up until it begins to separate from the frame.



Step 43

Insure that the body is lifting evenly. It may be necessary to lower the lift and place blocks on top of either the front two or the rear two lift pads. Continue experimenting until the body lifts equally all the way around.



Tech Tip 43

If you do not have a twin post lift you could position a floor jack in basically the same locations as the twin post lift arms.

Caution: Never work on a vehicle that is supported by a jack only. **ALWAYS USE SAFETY STANDS TO SUPPORT A RAISED VEHICLE.**



Step 44

CAREFULLY AND SLOWLY raise the body. Stop every 1/2 inch or so and check all the items disconnected previously, to insure they are not being stretched or damaged in any way. It is also advisable to check the entire vehicle for wiring, hoses, cables, tubing, etc. that may also be affected as the body and frame is being separated.





Step 45

Once the vehicle has been raised about 4 inches off of the frame, remove the upper and lower body bushing from the passenger side rear location. (See Figure A)



Step 47

Install one of the 3" diameter spacers as shown.

Note: It may be necessary to raise the body a little more to make room for this spacer.



Step 46

Remove and discard the sleeve (See Figure A). Keep the upper and lower body bushings. They will be reused.

Note: If these bushings are brittle and cracking we recommend replacing them. Click [HERE](#) to see what is available through **LOW RANGE OFF-ROAD**.



Step 48

Raise 3" body spacer and place the upper body bushing between the frame and the 3" spacer.

Note: Be sure the sleeve has been removed from the bushing. See Step 46.

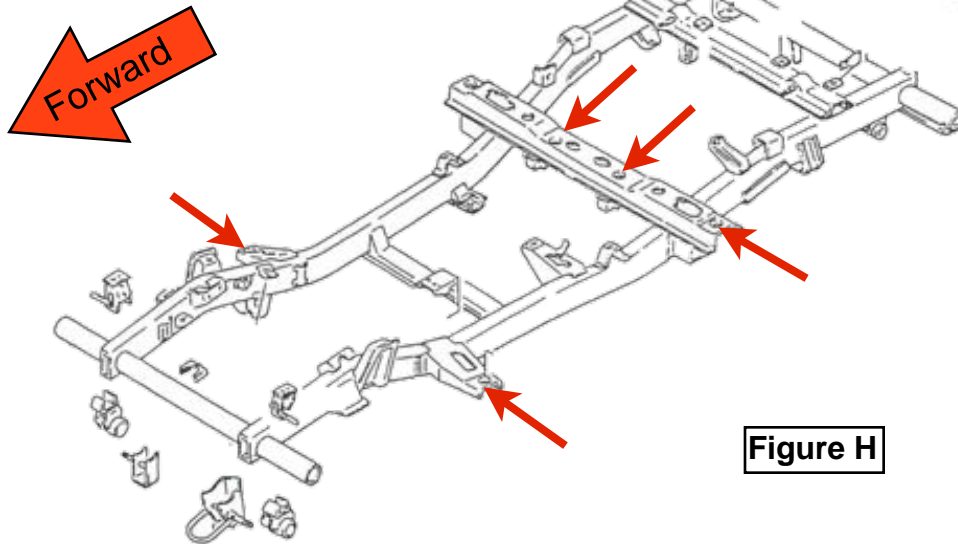

Figure H

Step 49 Repeat **Steps 45 through 48** at the other locations indicated by the arrows.



Step 50

Once all 6 of these spacers have been installed, lower the vehicle until the body is about a 1 inch above the spacers.



Step 51

It will likely be necessary to move the frame a bit one way or the other to have the body studs realign with the body bushings and frame holes. The frame can be moved front-to-rear by unblocking the wheels and rolling it. The frame can be moved side-to-side by placing a floor jack under the front or rear axle assembly and rolling the jack to the side.

Important: Take whatever time needed to do this step right. The studs must be perfectly centered in the spacers, the body bushings and the holes in the frame at **ALL 6** locations.



Step 52

Once all (6) studs are perfectly aligned with the holes in the frame, the body bushings and the spacers; continue lowering the body until the body is NEARLY resting on the spacers. You want to be able to move the spaces, just a little, for alignment purposes.



Tech Tip

You may find it helpful to use a pry bar to move the body or frame (side-to-side or front-to-back) to further align the stud extensions with the body studs.



Step 53

Beginning with the driver side front, position the original bottom body bushing and install the supplied stud extension and flat washer. (See Figure C & D). There are four 3" diameter spacers and two 2" diameter spacers. For proper spacer placement see Figure B. Do not tighten the stud extension at this point. Just start the threads 3 or 4 turns and leave it loose.

Note: We lifted the vehicle by the frame at this point so we could take pictures. It is not necessary for you to lift the vehicle up overhead at this point although you could if you wanted to.

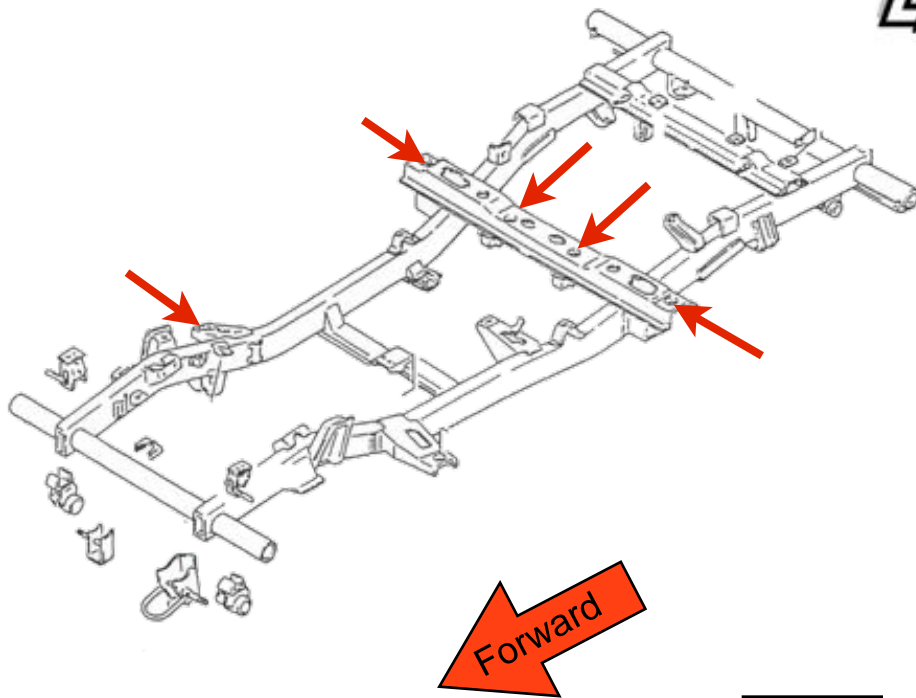

Figure 1

Step 54

Repeat **Step 53** on the other 5 body mounts indicated above.



INSTALLING THE REAR BODY SPACERS



Step 55

Place a 2" body spacer in the driver side rear as shown. See Figure E for an exploded view of proper hardware placement. Be sure you are using the 2" spacer with the small hole in the center.

Note 1: Make sure to leave the original body pad in place.

Note 2: It may be necessary to raise the body just a little to make room for these



Step 56

Install the supplied bolt, flat washer and lock washer. Align the body and start the bolt 3 or 4 turns. Do not tighten the bolt all the way yet.



Step 57

Repeat **Steps 55 & 56** on the passenger side rear mount.



INSTALLING THE FRONT BODY SPACERS



Step 58

Place a 2" body spacer (with the small hole) in the passenger side front as shown. See Figure E.

Note: Make sure to leave the original body pad in place.



Step 59

Install the supplied bolt, flat washer and lock washer. Align the body and start the bolt 3 or 4 turns. See Figure E. Leave this bolt loose for now.



Step 60

Repeat Steps 58 & 59 on the driver side front.



INSTALLING THE NO-HOLE BODY SPACERS



Step 61

Raise the body just enough to allow room for the 2" (no hole) spacers and the existing lift pads. See Figure F.

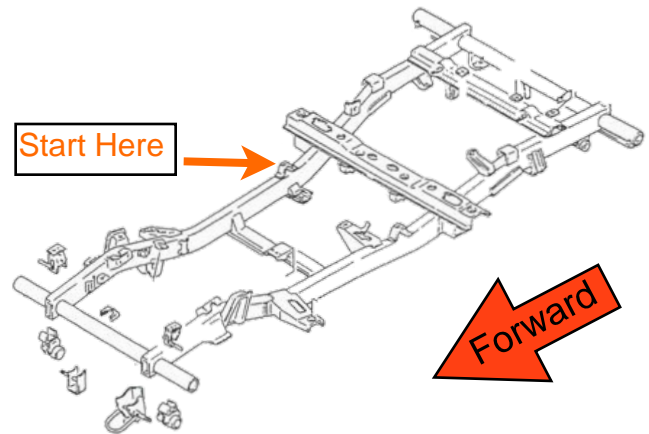
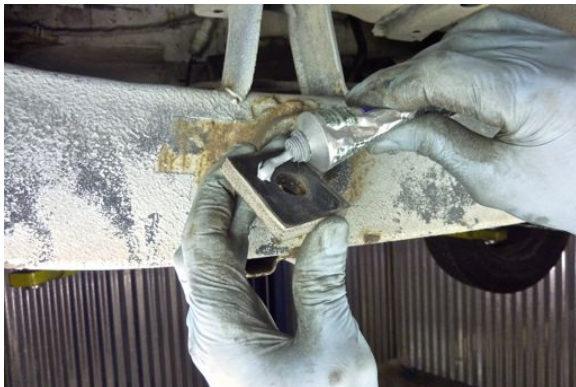

Figure J



Step 62

Starting at the location indicated in the above illustration (See Figure J), remove the existing body pad and apply the supplied Permatex Ultra Gray gasket maker to the bottom side.



Step 63

Place the pad in exactly the same location as it was originally, with the "gasket maker" side down.



Step 64

Apply a 1/16" layer of gasket maker to one side of a 2" diameter (no hole) spacer.



Step 65

Repeat the previous step on the other end of the 2" spacer.



Step 66

Position the spacer on top of the body pad.



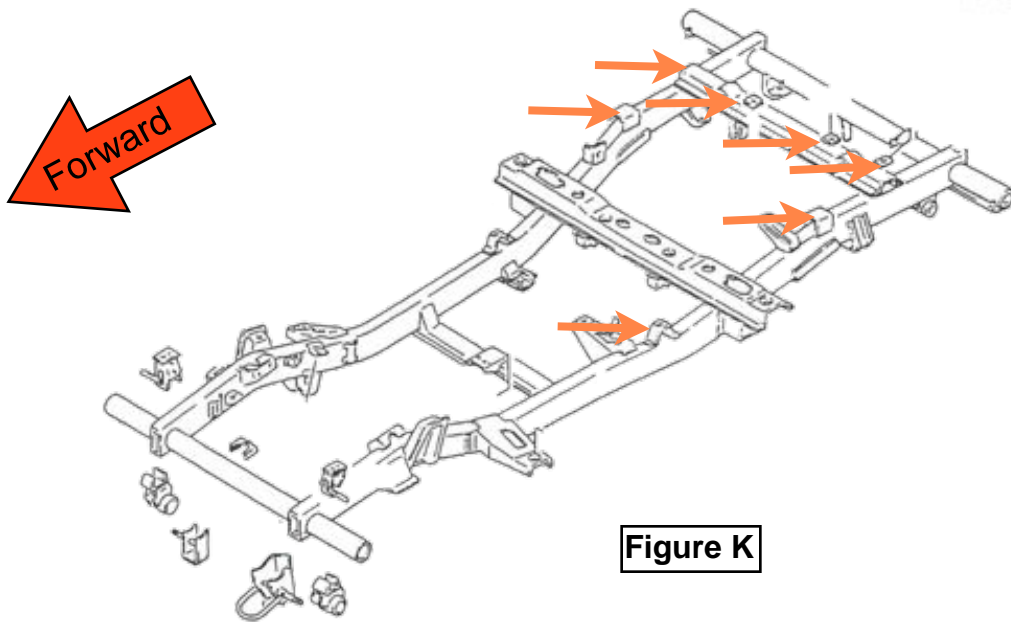
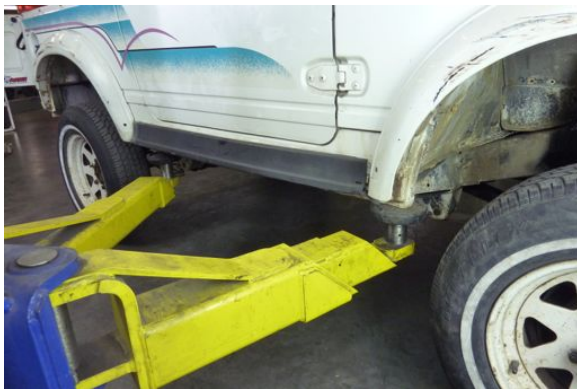

Figure K

Step 67

Repeat **Steps 62 through 66** on the locations indicated by the arrows shown above. See Figure K.



Step 68

Once all (8) pads are in place, lower the body until the body weight is resting on the spacers and frame.



Step 69

Tighten the (2) front and (2) rear body bolts using a 17 mm socket. The torque specification is 15 ft. lbs.





Step 70

If you are working with a twin post lift, raise the vehicle back up overhead. Be sure to reposition the lift pads on the frame and spring mounts, as shown at the beginning of these instructions.

CAUTION: DO NOT LIFT THE VEHICLE BY LIFTING ON THE BODY.



Step 72

Reposition and tighten the large fuel tank hose clamp.

Note: This hose will likely be about 1 1/2 inches lower than it was originally.



Step 71

Go back through and tighten all (6) stud extensions using a 19 mm socket. The stud extensions should be torqued to 15 ft. lbs.

If the vehicle is raised at this point, lower it to the floor.



Tech Tip 72

Insure that the filler hose is not kinked at any point, particularly in the location shown by the arrow. If it is kinked, loosen the hose clamp, slide it down a bit more and retighten the clamp.

Note: If this hose needs replacing click [HERE](#) to see what is available through **LOW RANGE OFF-ROAD**.



Step 73

Reposition the vent (smaller hose) hose clamp. There is usually plenty of slack available with this hose which reduces the risk of kinking. However, if kinking is observed, simply loosen the hose clamp, slide the hose down a bit and tight the clamp.



Step 74

Replace the liquid vapor separator bottle.



Step 75

Replace the fuel hose upper cover.



Step 76

Replace the fuel hose lower cover. The third bolt indicated by the arrow will not reach the hole in the body. You could make a custom bracket if desired. We feel the cover is secured well enough with 2 of the 3 bolts.



Step 77

Reconnect the air inlet assembly.

Note: The air duct may need to be compressed (reduced in length) a little, but it should fit just fine.



Tech Tip 77

Be sure to reconnect this vacuum tube.



Step 78

Reconnect the temperature control cable to the control valve bracket.

Note: Be sure to position the cable in the exact position as it was before disassembly so that the proper adjustment can be maintained. If you find you need temperature control cable adjustment instructions click [HERE](#) and go to Step 31.



Step 79

Reconnect the temperature control valve to the firewall.

Note: There are 2 screws here.



Step 80

Reconnect the canister vacuum tube.



Step 81

Reconnect the distributor primary wire connector.



Step 82

Reconnect the oil pressure wire restraint.



Step 83

Reconnect the steering shaft.

Note: Make sure to realign the marks you made earlier. If not done correctly the steering wheel will be up-side-down.



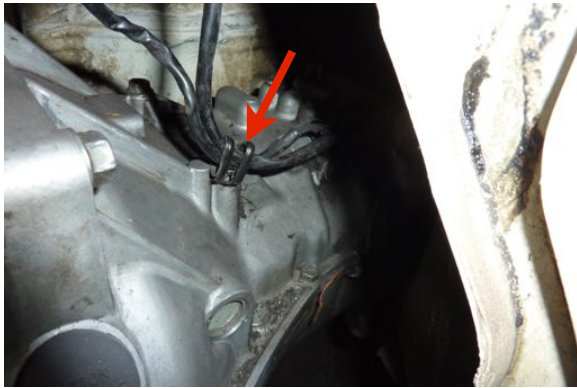

Step 84

Reconnect the transmission and transfer case wire restraint.



Step 85

Most likely, the brake line bracket holes will not align. Most folks simply leave the screws out. However, you could make a custom bracket to support this bracket or drill new holes in the inner fender.



Step 86

Align the driver side pegs with the holes in the fender.



Step 87

Flex the grill out by the passenger side headlight and insert the grill pegs in the fender holes.





Step 88

Reinstall the (5) screws securing the grill to the vehicle.

Final Checks & Steps



Step 89

Check the transmission shifter boot. Slide it up if needed. Check for proper shifter operation by moving the shifter into all the gears. We did not have any shifter problems with our installation but some have reported a need to trim the body and or boot bracket.



Step 90

Repeat the previous step with the transfer case shifter.

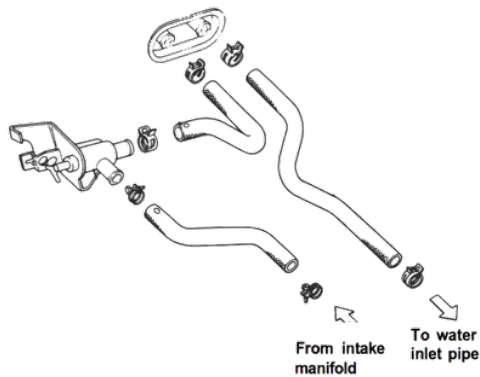

Tech 91

Check to see that the heater hoses are properly positioned and clamps secure.

Step 92

Reconnect the negative battery cable.



Congratulations:

You have successfully completed a Samurai body lift. We hope these instructions have been helpful. If you have suggestions on how we can improve these instructions or our products email us at sales@lowrangeoffroad.com or call us at 801-805-6644.

As always, If you experience any difficulty during the installation of this product please contact Low Range Off-Road Technical Support at 801-805-6644 M-F 7:30am-5:30pm MST. Thank you for purchasing from Low Range Off-Road.



These instructions are designed as a general installation guide. Installation of many Low Range Off-Road products require specialized skills such as metal fabrication, welding and mechanical trouble shooting. If you have any questions or are unsure about how to proceed, please contact our shop at 801-805-6644 or seek help from a competent fabricator. Using fabrication tools such as welders, torches and grinders can cause serious bodily harm and death. Please operate equipment carefully and observe proper safety procedures.

Rock crawling and off-road driving are inherently dangerous activities. Some modifications will adversely affect the on-road handling characteristics of your vehicle. All products sold by Low Range Off-Road are sold for off road use only. Any other use or application is the responsibility of the purchaser and/or user. Some modifications and installation of certain aftermarket parts may under certain circumstances void your original dealer warranty. Modification of your vehicle may create dangerous conditions, which could cause roll-overs resulting in serious bodily injury or death. Buyers and users of these products hereby expressly assume all risks associated with any such modifications and use.

Revised 11/18/13© Copyright 2013 Low Range Off-Road, LC All Rights Reserved

